



**klimaoprema**  
CLEANROOM SOLUTIONS

## Inox Namještaj





## Cleanroom namještaj

Cleanroom namještaj izrađen je iz nehrđajućeg čelika AISI 304 ili AISI 316. Elementi namještaja izrađeni su iz zvučno izoliranih panela, čvrsto zavareni i obrađeni kako bi se spriječila mogućnost sakupljanja bakterija. Svi elementi (ručke, sudoperi, podesive nogice i dr.) integrirani u namještaj izrađeni su iz nehrđajućeg čelika. Svi dijelovi namještaja lako su perivi, a površine su otporne na sredstva za čišćenje i dezinficijense koji se koriste u čistom prostoru. Cleanroom namještaj proizveden je u skladu sa EU GMP i ISO 14644 zahtjevima.

### Opis ikona:

 AISI 304	Nehrdajući čelik 304	 TRESPA	Radna površina iz trespe
 AISI 316	Nehrdajući čelik 316	 RAL	RAL boje prema zahtjevu
 Polirana površina	Polirana površina	 Ormar bez vrata	Ormar bez vrata
 Satinirana površina	Satinirana površina	 Ormar s vratima	Ormar s vratima
 Sudoper sa slavinom	Sudoper sa slavinom	 Ormar sa staklenim vratima	Ormar sa staklenim vratima
 Sudoper bez slavine	Sudoper bez slavine	 Ormar s kliznim vratima	Ormar s kliznim vratima
 Sudoper sa senzor slavinom	Sudoper sa senzor slavinom	 Ladice s ključem	Ladice s ključem
 Do 3 ladice	Do 3 ladice	 Kosi krov	Kosi krov
 Donja polica za stol	Donja polica za stol	 Ventilirani ormar	Ventilirani ormar
 Prednja maska pokriva sudoper	Prednja maska pokriva sudoper	 Ormar s ladicama	Ormar s ladicama
 Donje ladice	Donje ladice	 Ormar s vješalicom	Ormar s vješalicom
 Perforirani čelik	Perforirani čelik	 Ormar s ladicama i vješalicom	Ormar s ladicama i vješalicom
 Radna površina iz granita	Radna površina iz granita	 Klupica s odjeljkom za cipele	Klupica s odjeljkom za cipele
 kerrock	Radna površina iz čvrstog materijala. Ostale vrste na upit	 Klupica bez odjeljka za cipele	Klupica bez odjeljka za cipele



Sudoperi | Kirurška Korita





## SU-J

Dužina (mm) A	Dubina (mm) B	Visina (mm) H
800	600	900
1000	600	900
1200	600	900

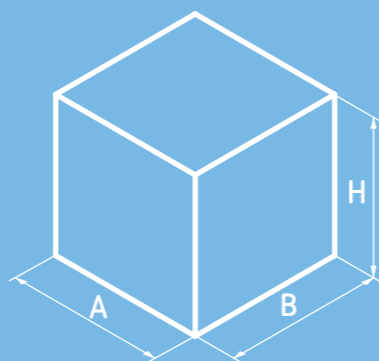

## KR

Dužina (mm) A	Dubina (mm) B	Visina (mm) H
1200	600	800
1500	600	800
1800	600	800

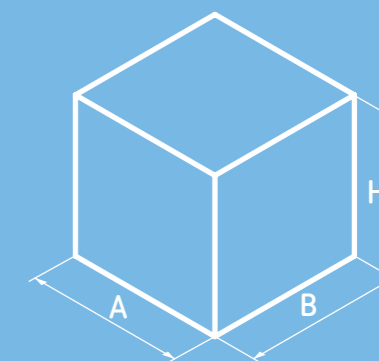

Materijal:



Opcije:



Materijal:



Opcije:



## SU-D

Dužina (mm) A	Dubina (mm) B	Visina (mm) H
1000	600	900
1200	600	900
1400	600	900

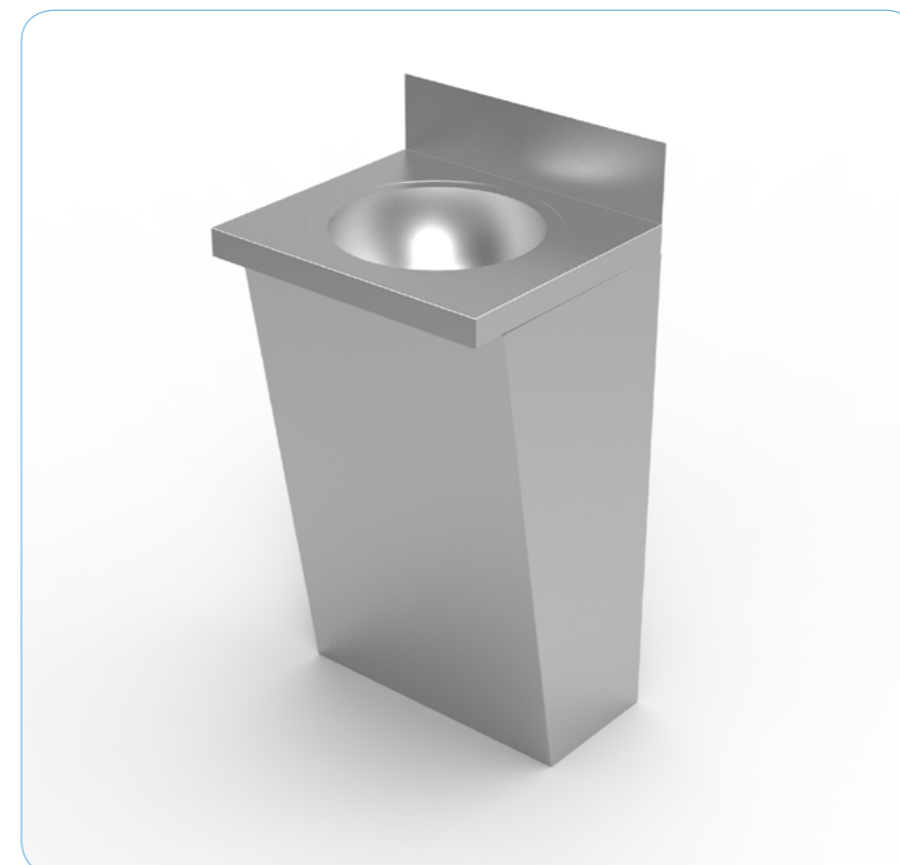
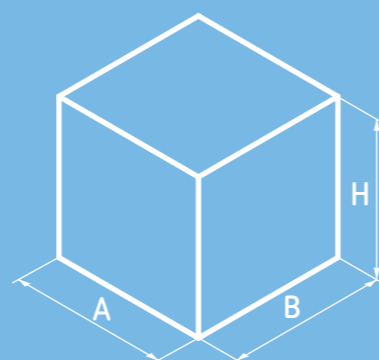

## UM

Dužina (mm) A	Dubina (mm) B	Visina (mm) H
400	400	900
500	500	900
600	600	900

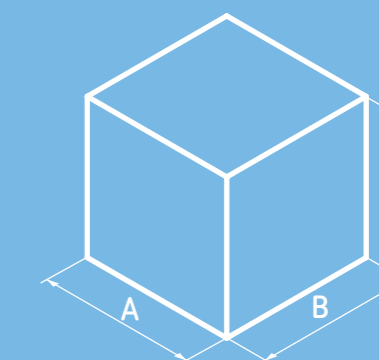



Stolovi





## ST

Dužina (mm) A	Dubina (mm) B	Visina (mm) H
1600	600	750/900
1700	600	750/900
1800	600	750/900

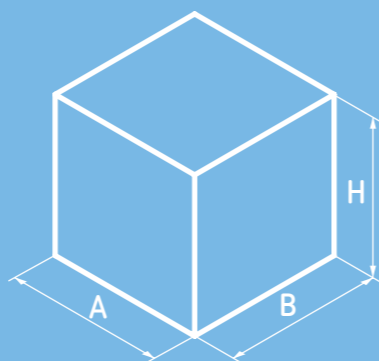

Materijal:

AISI 304

AISI 316



Opcije:



## ST-U

Dužina (mm) A	Dubina (mm) B	Visina (mm) H
1600	600	750/900
1700	600	750/900
1800	600	750/900

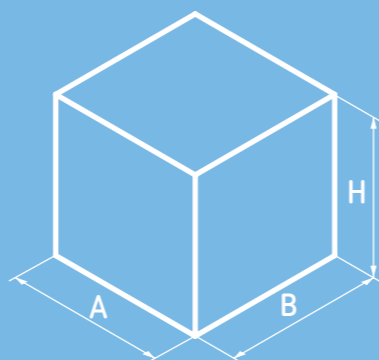

## ST-V1

Dužina (mm) A	Dubina (mm) B	Visina (mm) H
1600	600	750/900
1700	600	750/900
1800	600	750/900

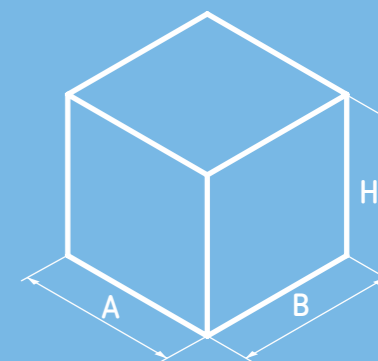

Materijal:

AISI 304

AISI 316



Opcije:



## ST-V2

Dužina (mm) A	Dubina (mm) B	Visina (mm) H
1600	600	750/900
1700	600	750/900
1800	600	750/900

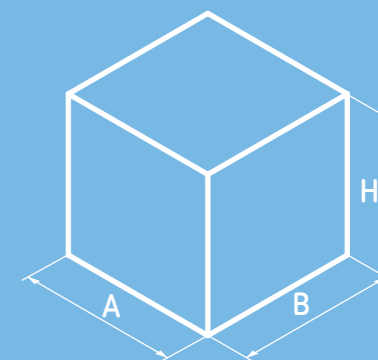

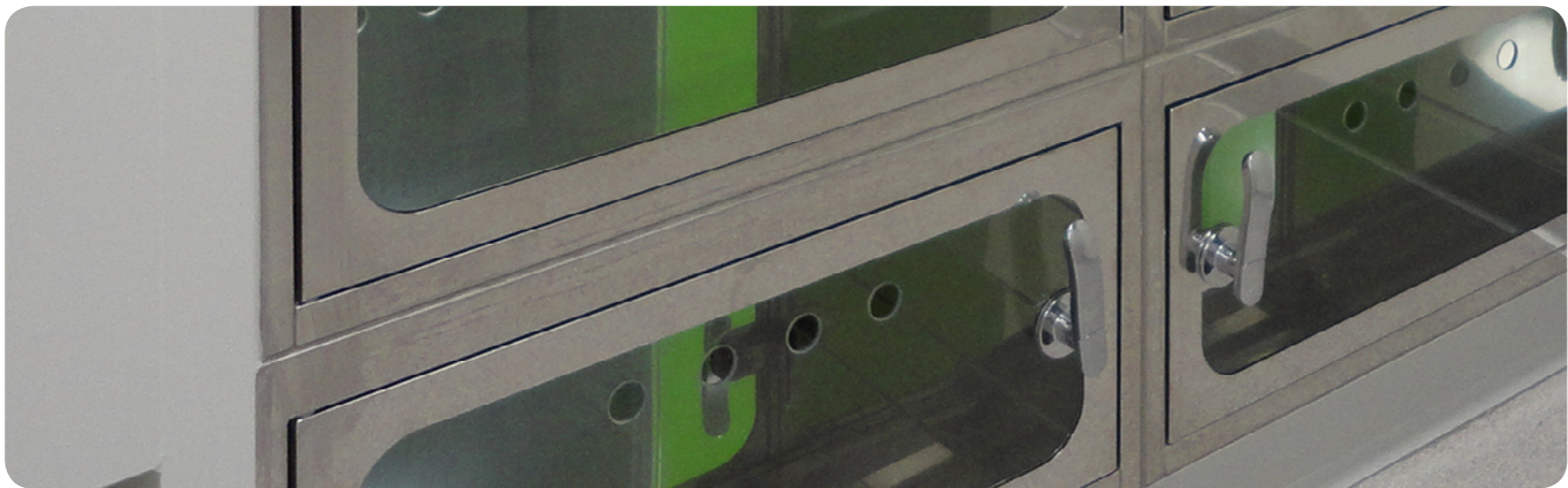

Police





## PO

Dužina (mm) A	Dubina (mm) B	Visina (mm) H
600	400	1800
800	400	1800
1000	400	1800

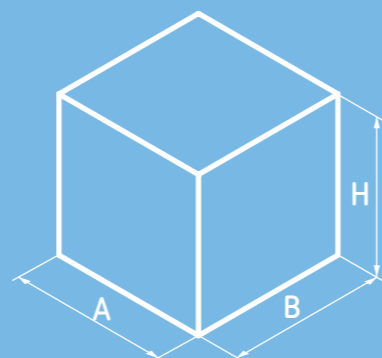

Materijal:

AISI  
304

AISI  
316



Opcije:



## PO-PF

Dužina (mm) A	Dubina (mm) B	Visina (mm) H
600	400	1800
800	400	1800
1000	400	1800

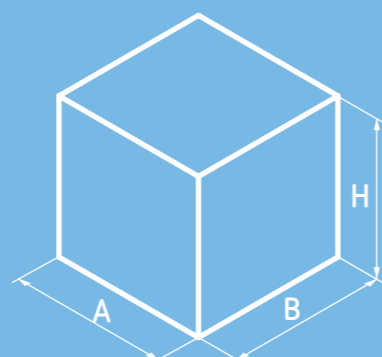

Materijal:

AISI  
304

AISI  
316



Opcije:

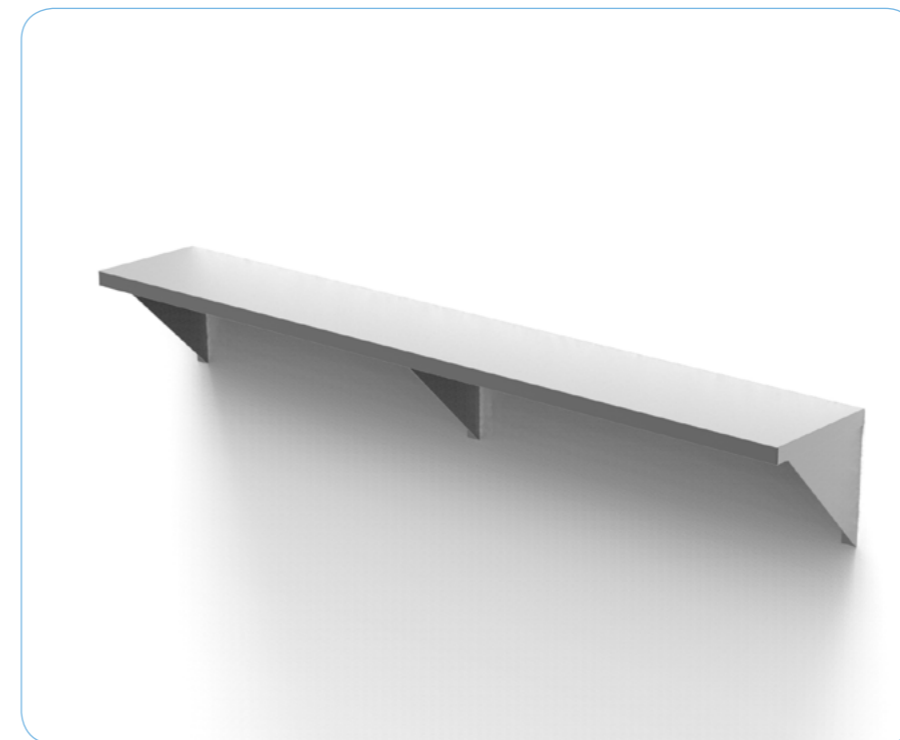

## PO-Z1

Dužina (mm) A	Dubina (mm) B	Visina (mm) H
1200	250	250
1400	250	250
1600	250	250

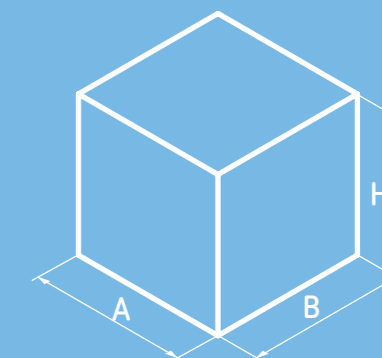

Materijal:

AISI  
304

AISI  
316



Opcije:



## PO-Z2

Dužina (mm) A	Dubina (mm) B	Visina (mm) H
800	500	800
1000	500	800
1200	500	800

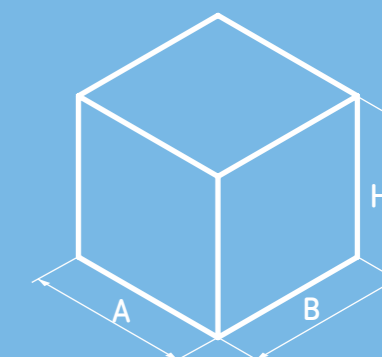

Materijal:

AISI  
304

AISI  
316



Opcije:





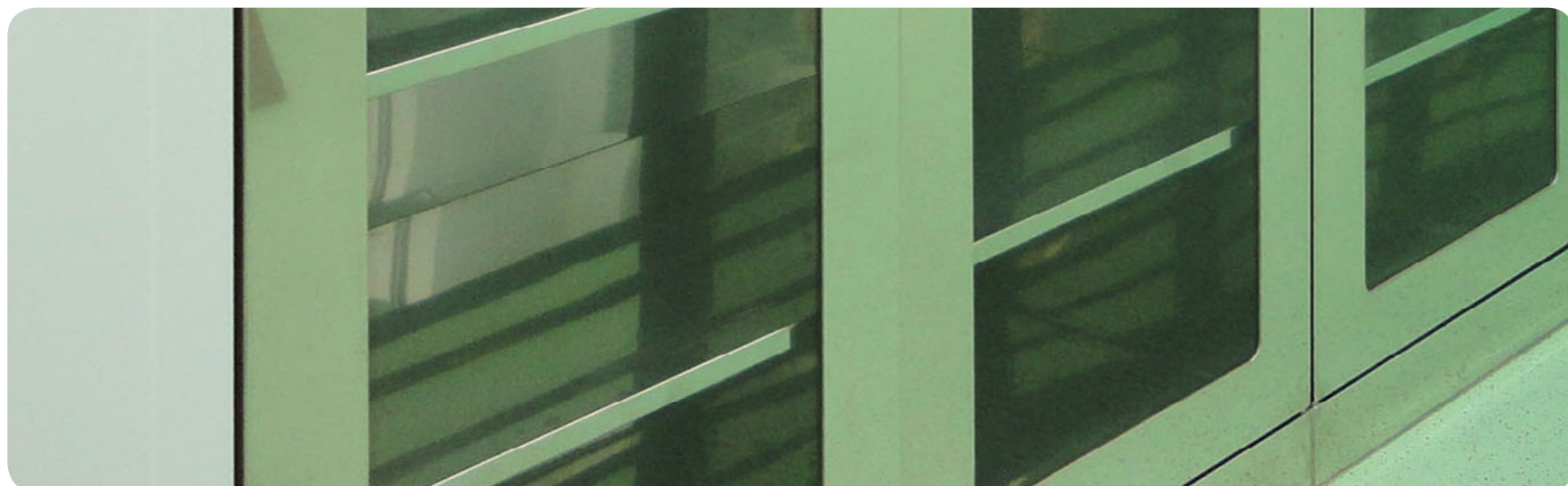

Ormari



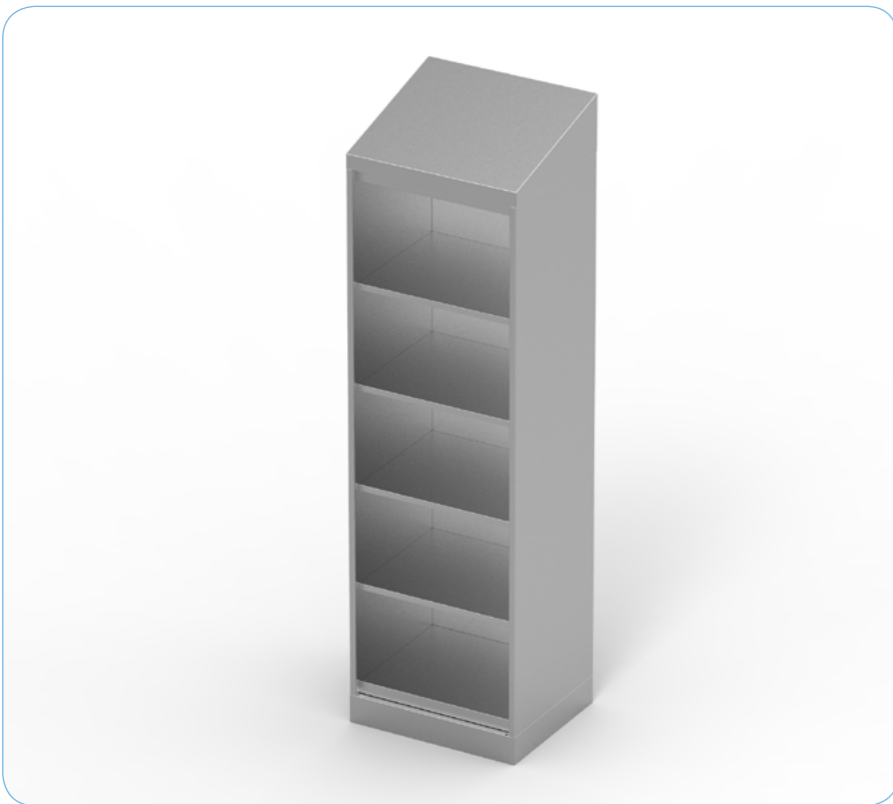

## OR-J1

Dužina (mm)	Dubina (mm)	Visina (mm)
A	B	H
400	400	2000
500	400	2000
600	400	2000

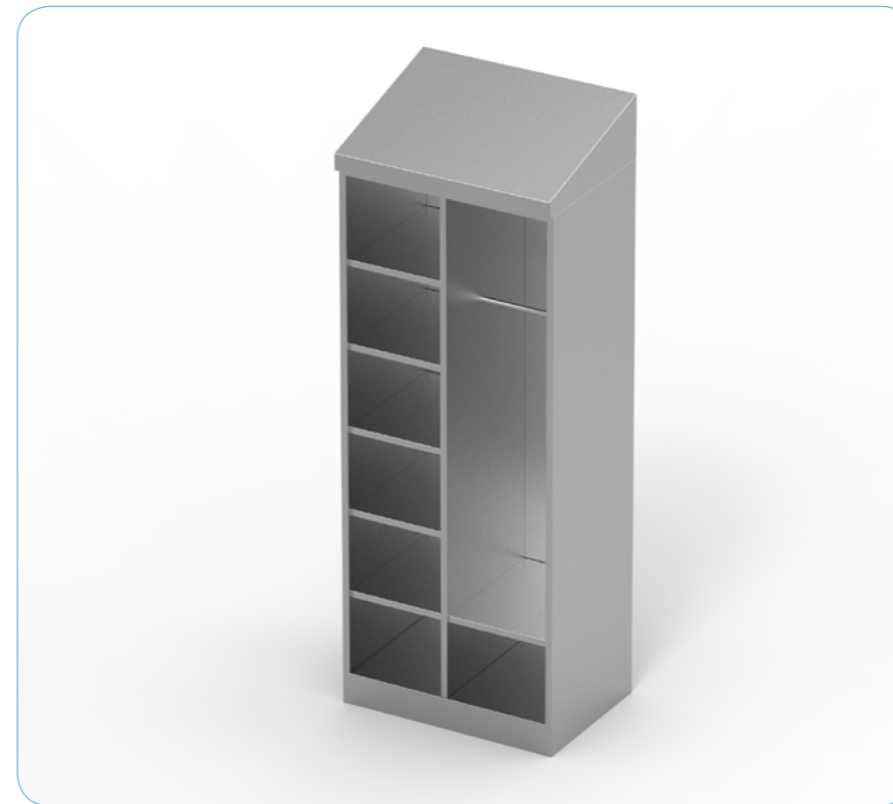
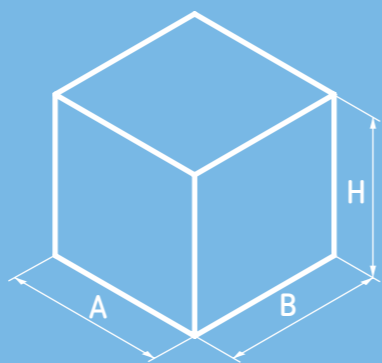

## OR-D1

Dužina (mm)	Dubina (mm)	Visina (mm)
A	B	H
800	400	2000
1000	400	2000
1200	400	2000

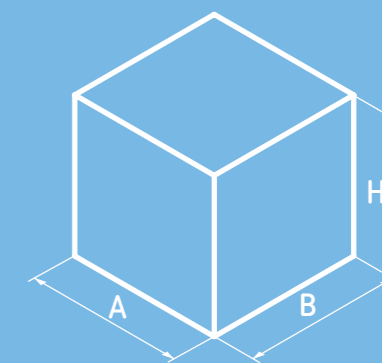

Materijal:



Opcije unutrašnjosti:



Opcije vrata:



Druge opcije:



Materijal:



Opcije unutrašnjosti:



Opcije vrata:



Druge opcije:



## OR-J2

Dužina (mm)	Dubina (mm)	Visina (mm)
A	B	H
400	400	2000
500	400	2000
600	400	2000

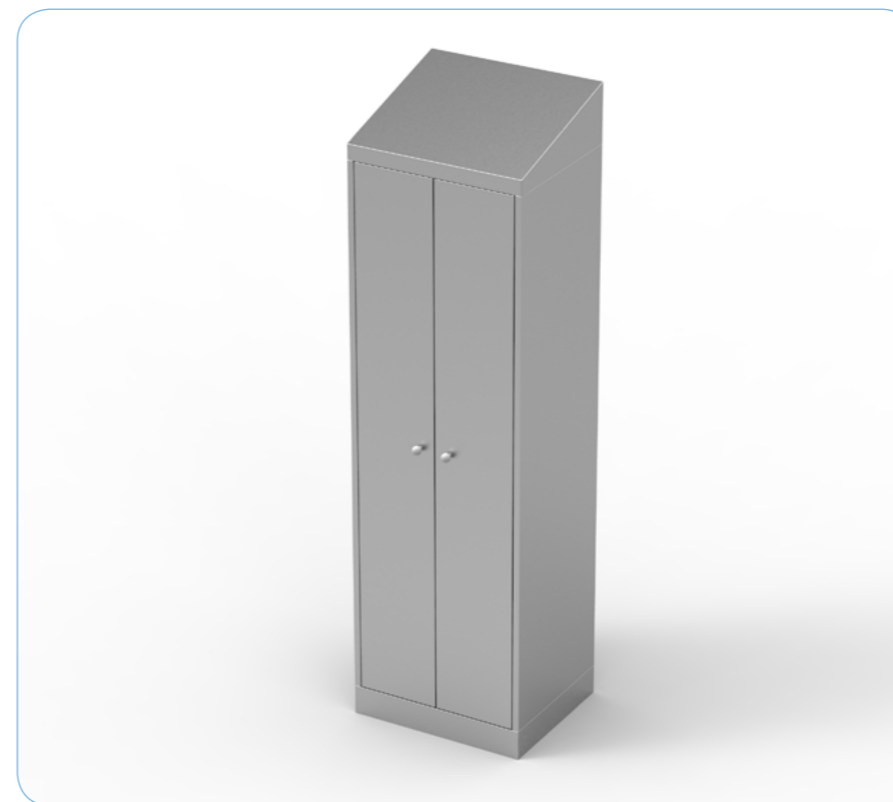
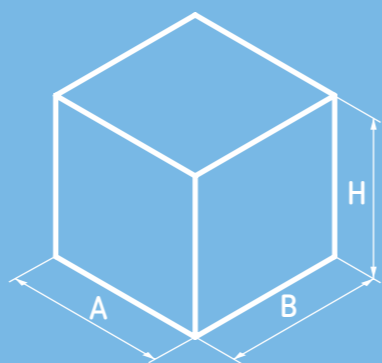

## OR-D2

Dužina (mm)	Dubina (mm)	Visina (mm)
A	B	H
800	400	2000
1000	400	2000
1200	400	2000

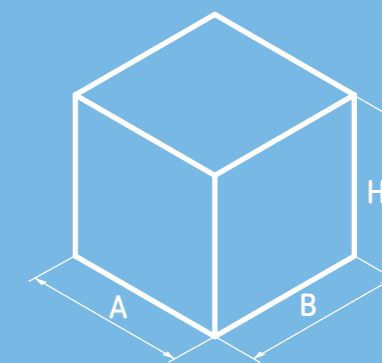

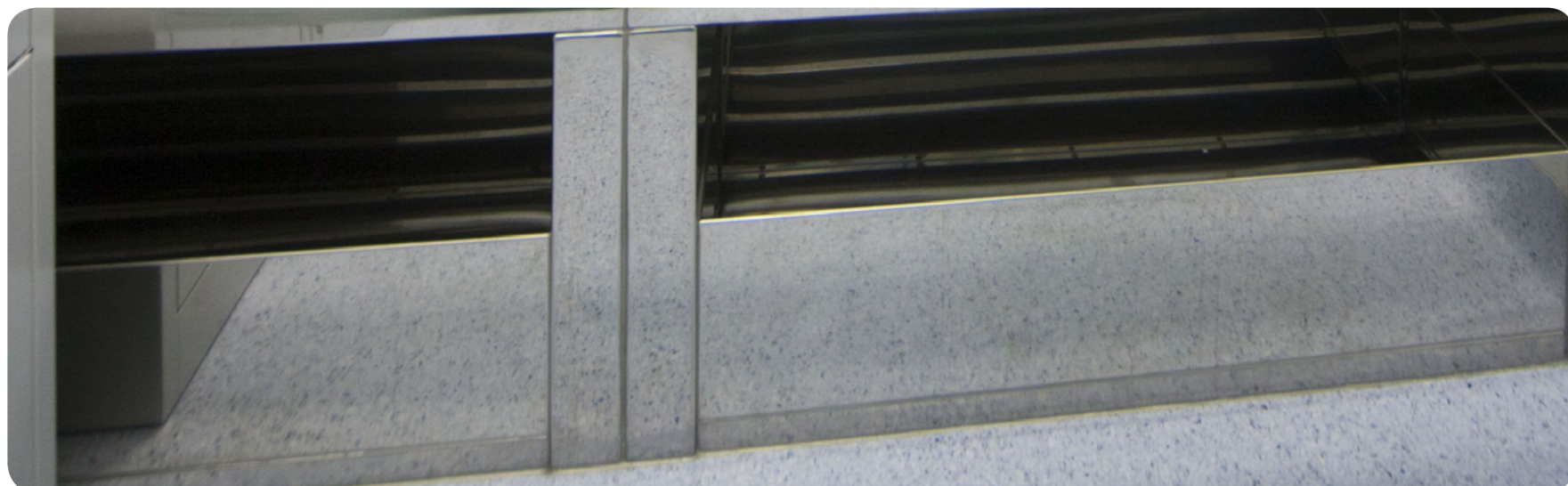

Klupice | Ladičari | Kolica

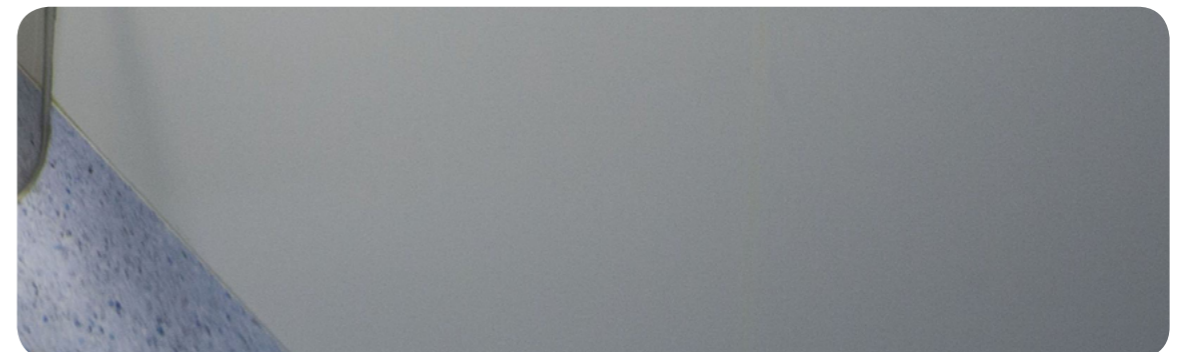



## LA

Dužina (mm) A	Dubina (mm) B	Visina (mm) H	Ladice
400	500	675	3
400	500	850	4
400	500	1025	5

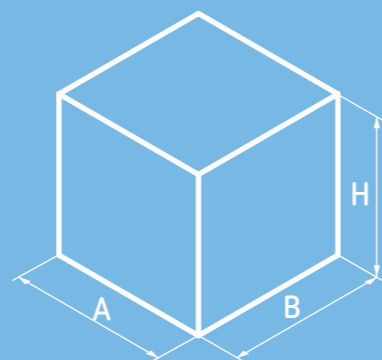

Materijal:

AISI  
304

AISI  
316



Opcije:



## KO

Dužina (mm) A	Dubina (mm) B	Visina (mm) H
900	600	900
1000	600	900
1100	600	1100

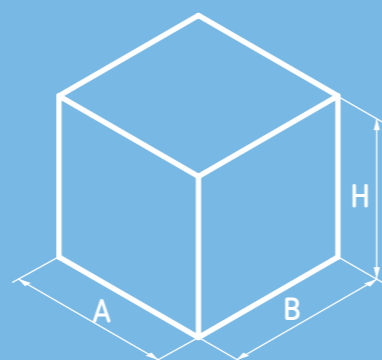

Materijal:

AISI  
304

AISI  
316

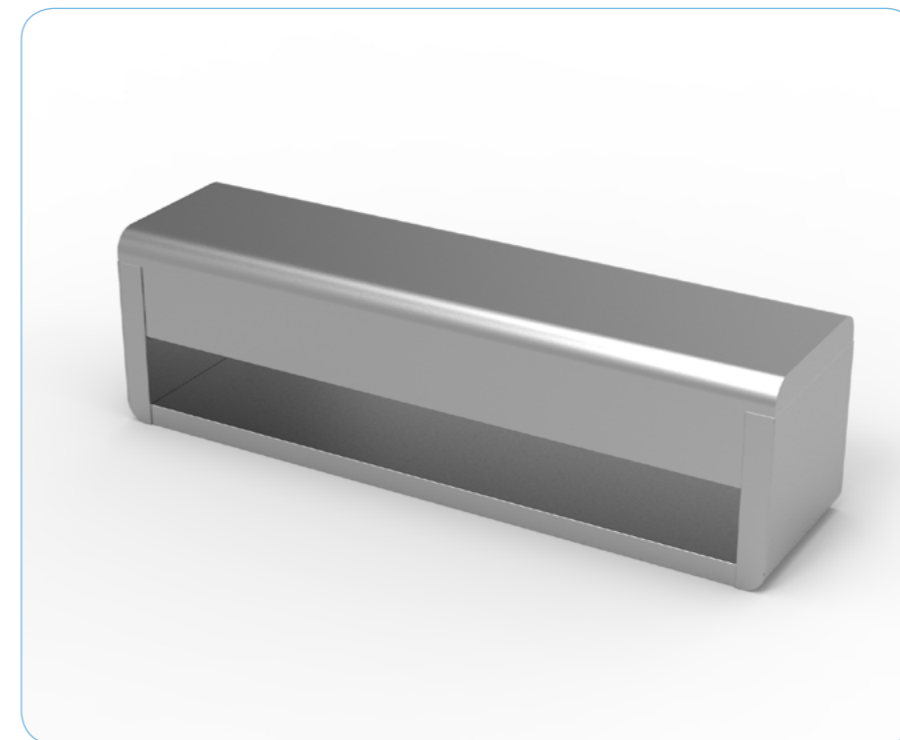

## KL

Dužina (mm) A	Dubina (mm) B	Visina (mm) H
800	400	450
1000	400	450
1200	400	450

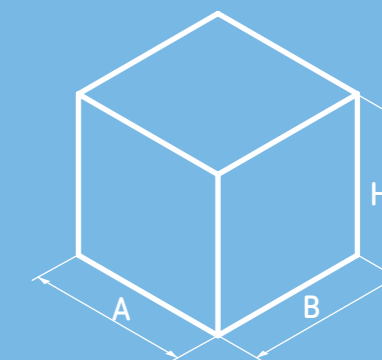

Materijal:

AISI  
304

AISI  
316



Opcije:



## DS

Dužina (mm) A	Dubina (mm) B	Visina (mm) H	Utori
400	200	500	2
600	200	500	3
800	200	500	4

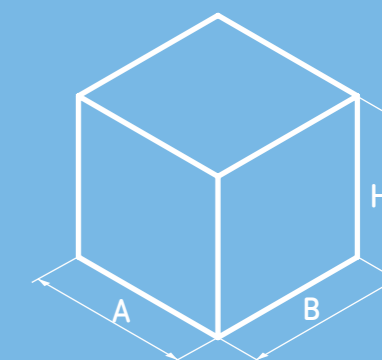

Materijal:

AISI  
304

AISI  
316





Inox odbojnici



### Zidni odbojnik

	Širina (mm) A
Minimum	160
Maximum	2950

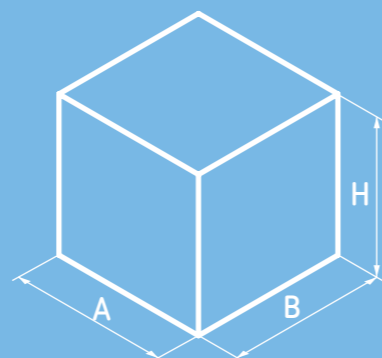

Materijal:



### Podni odbojnik

	Širina (mm) A
Minimum	300
Maximum	2100

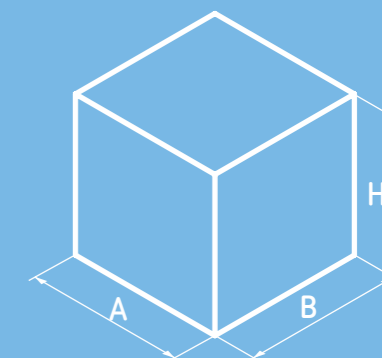

Materijal:

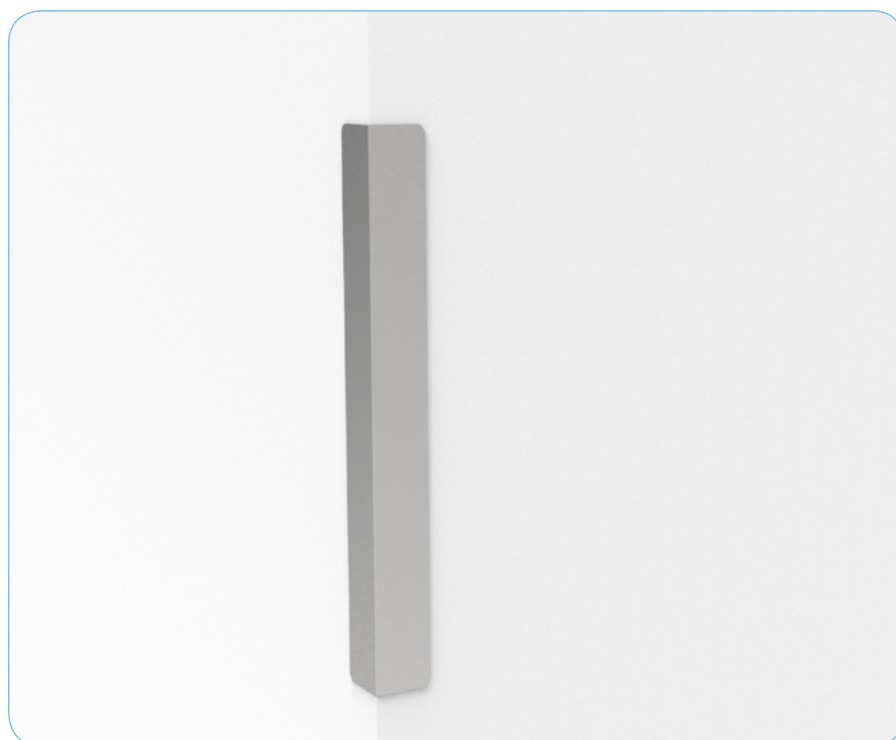

### Zidni kutni odbojnik

Dužina (mm) A	Širina (mm) B	Visina (mm) H
65	65	100 (min.) - 3000 (max.)

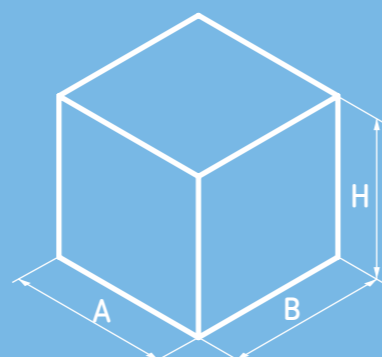

Materijal:



### Podni kutni odbojnik

	Dužina (mm) A	Širina (mm) B
Minimum	350	350
Maximum	2100	2100

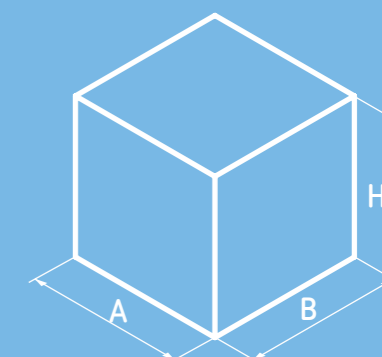

Materijal:



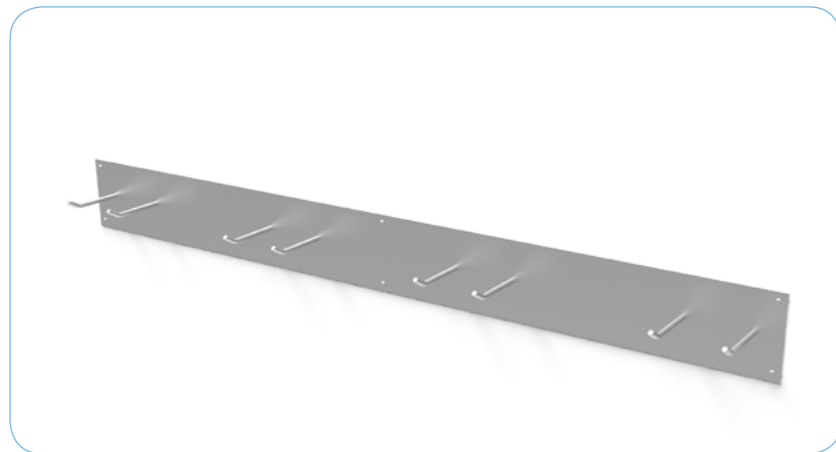
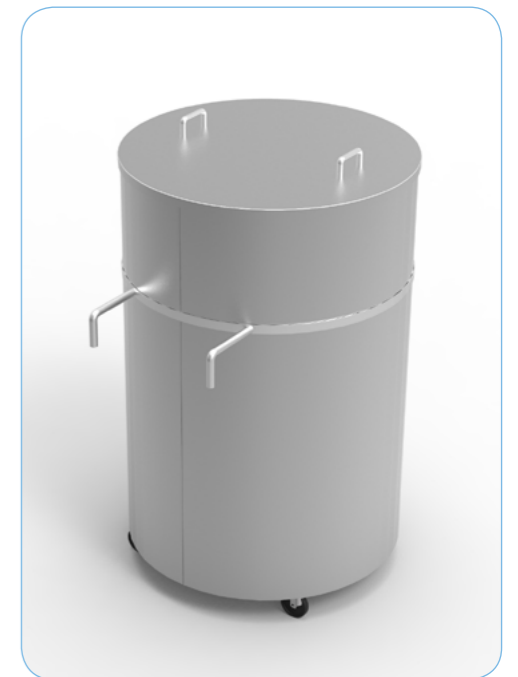
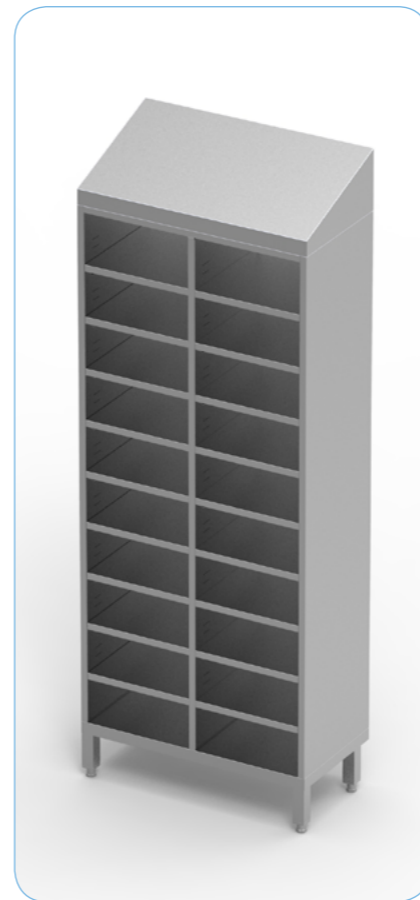

Ostali namještaj na zahtjev



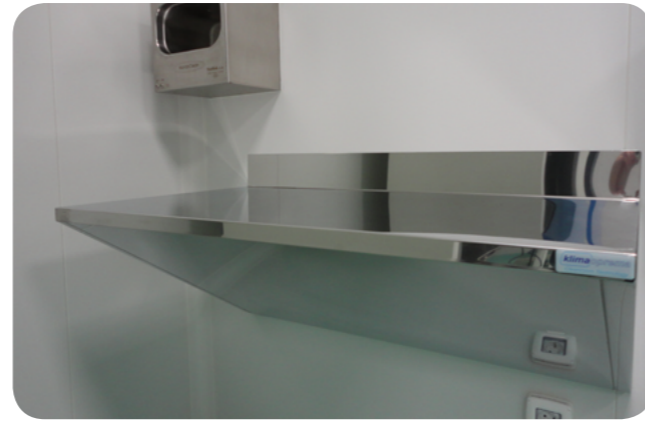

# Reference

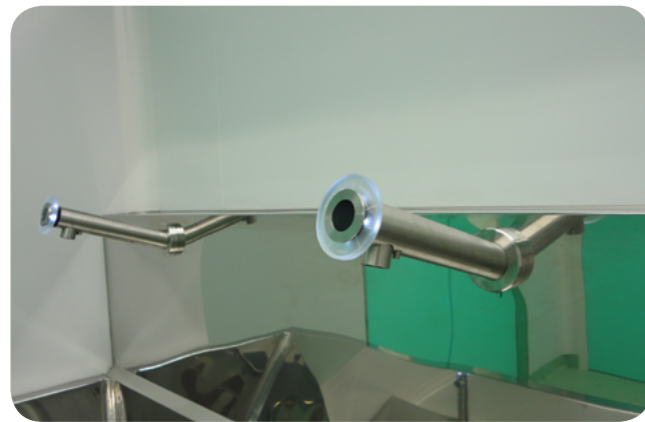





Adresa: Gradna 78A,  
10430 Samobor, Croatia  
Tel.: +385 1 33 62 513  
Fax.: +385 1 33 62 905  
Mail.: info@klimaoprema.hr  
Web: www.klimaoprema.hr

Studen, 2019

